

BENKO PRODUCTS INC.

SELF-CLOSING SAFETY GATE: SWING GATE MODEL

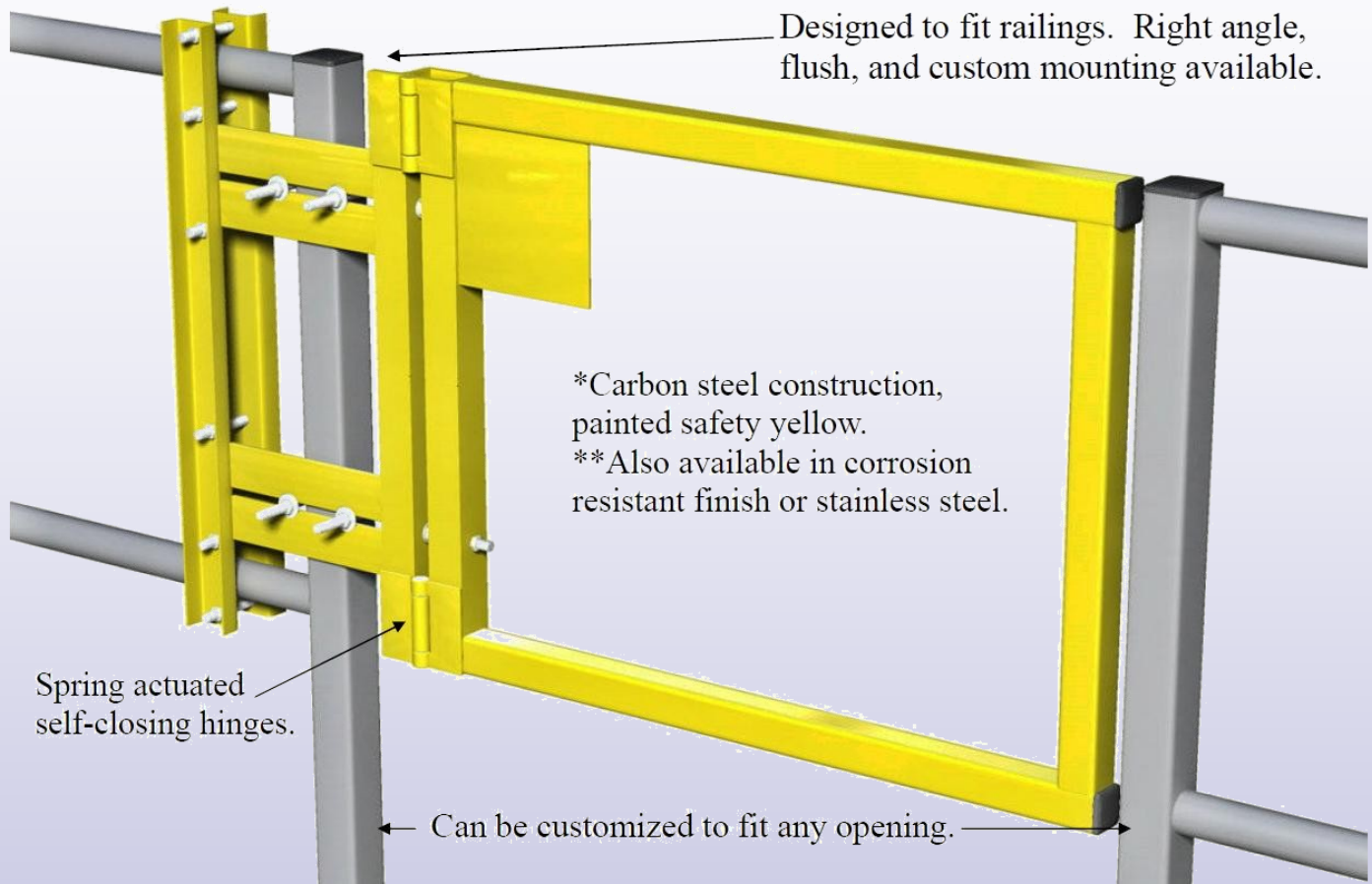

Ideal for Stair Openings, Ladders, and Platforms

The Protect-O-Gate Swing Gate is pre-fabricated and bolts to existing rail openings to provide a one-way, self-closing gate. It is a simple and cost-effective solution to comply with OSHA regulations.

Features:

- Carbon steel construction (avail. In Stainless)
- Painted safety yellow (spec. finishes avail.)
- **Can be customized to fit any opening size. ***
- Steel spring self-closing action.
- Easy to install. Special mountings available.



Benko Products, Inc. 5350 Evergreen Pkwy Sheffield Village, OH 44054
Phone: (440) 934-2180 Fax: (440) 934-4052 email: info@benkoproducts.com
www.benkoproducts.com

BENKO PRODUCTS INC.

Self-Closing Safety Gate: Swing Gate Model

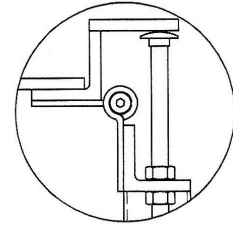
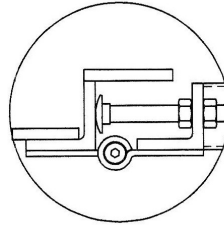
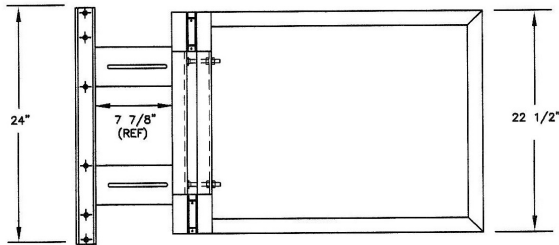

TOP VIEW OF SWING GATE WITH INLINE MOUNTING

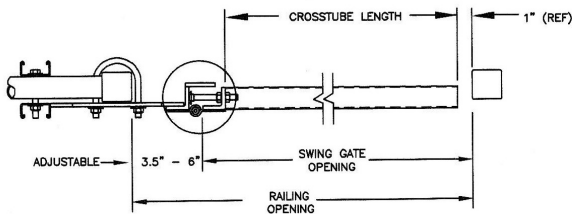

TOP VIEW OF SWING GATE WITH 90° MOUNTING

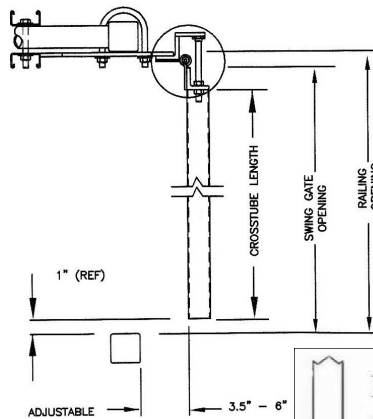

Ladder Mounted Self-Closing Safety Gate

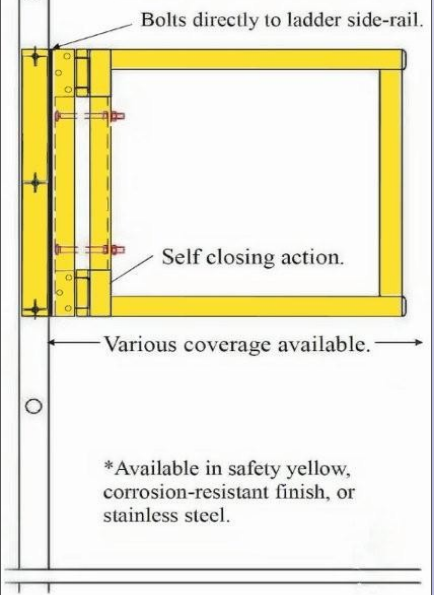

Full Swing Gate w/ 3rd rail and kickplate

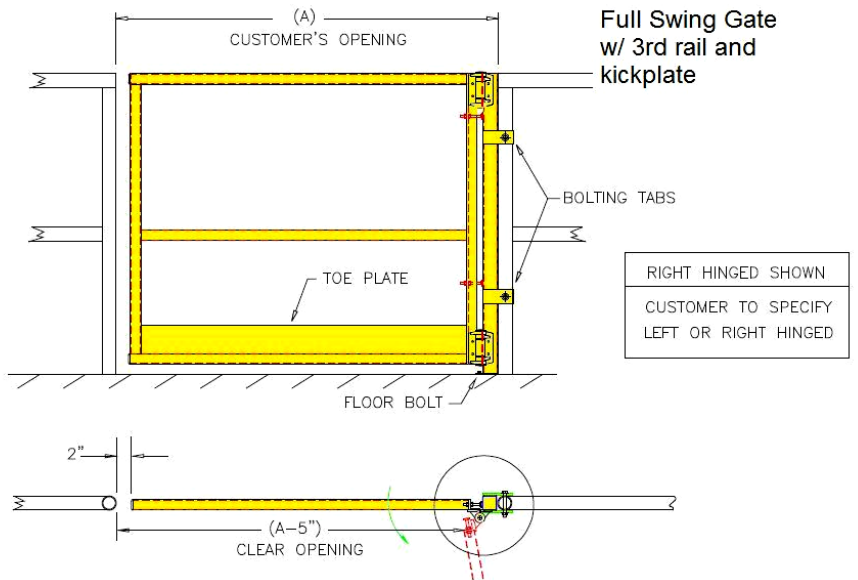

RIGHT HINGED SHOWN
CUSTOMER TO SPECIFY
LEFT OR RIGHT HINGED

Benko Products, Inc. 5350 Evergreen Pkwy Sheffield Village, OH 44054
 Phone: (440) 934-2180 Fax: (440) 934-4052 email: info@benkoproducts.com
www.benkoproducts.com

BENKO PRODUCTS INC.

Self-Closing Safety Gate: Swing Gate Model

Gate Size	Fits Clear Opening*	Estimated Weight	Material	Cost
16	17" to 18 1/2"	34 lbs.	Carbon Steel	\$186.00
			CS w/corrosion resistant finish	\$210.00
			304 Stainless Steel	Call for quote
18	19" to 21 1/2"	35 lbs.	Carbon Steel	\$189.00
			CS w/corrosion resistant finish	\$213.00
			304 Stainless Steel	Call for quote
21	22" to 24 1/2"	35 lbs.	Carbon Steel	\$194.00
			CS w/corrosion resistant finish	\$218.00
			304 Stainless Steel	Call for quote
24	25" to 27 1/2"	36 lbs.	Carbon Steel	\$197.00
			CS w/corrosion resistant finish	\$231.00
			304 Stainless Steel	Call for quote
27	28" to 30 1/2"	36 lbs.	Carbon Steel	\$199.00
			CS w/corrosion resistant finish	\$223.00
			304 Stainless Steel	Call for quote
30	31" to 33 1/2"	37 lbs.	Carbon Steel	\$204.00
			CS w/corrosion resistant finish	\$228.00
			304 Stainless Steel	Call for quote
33	34" to 36 1/2"	37 lbs.	Carbon Steel	\$208.00
			CS w/corrosion resistant finish	\$232.00
			304 Stainless Steel	Call for quote
36	37" to 39 1/2"	38 lbs.	Carbon Steel	\$210.00
			CS w/corrosion resistant finish	\$234.00
			304 Stainless Steel	Call for quote

Custom sizes and finishes available. Contact Us for details.

Benko Products, Inc. 5350 Evergreen Pkwy Sheffield Village, OH 44054
 Phone: (440) 934-2180 Fax: (440) 934-4052 email: info@benkoproducts.com
www.benkoproducts.com